

ATF 40G-2

40 TON MAX. LIFTING CAPACITY

EUROMOT 3A

ALL TERRAIN CRANE



Maße (mm)
 Dimensions (mm)
 Dimensiones (mm)

385/95 R 25
 (14.00 R 25)

DIN/ISO/EN

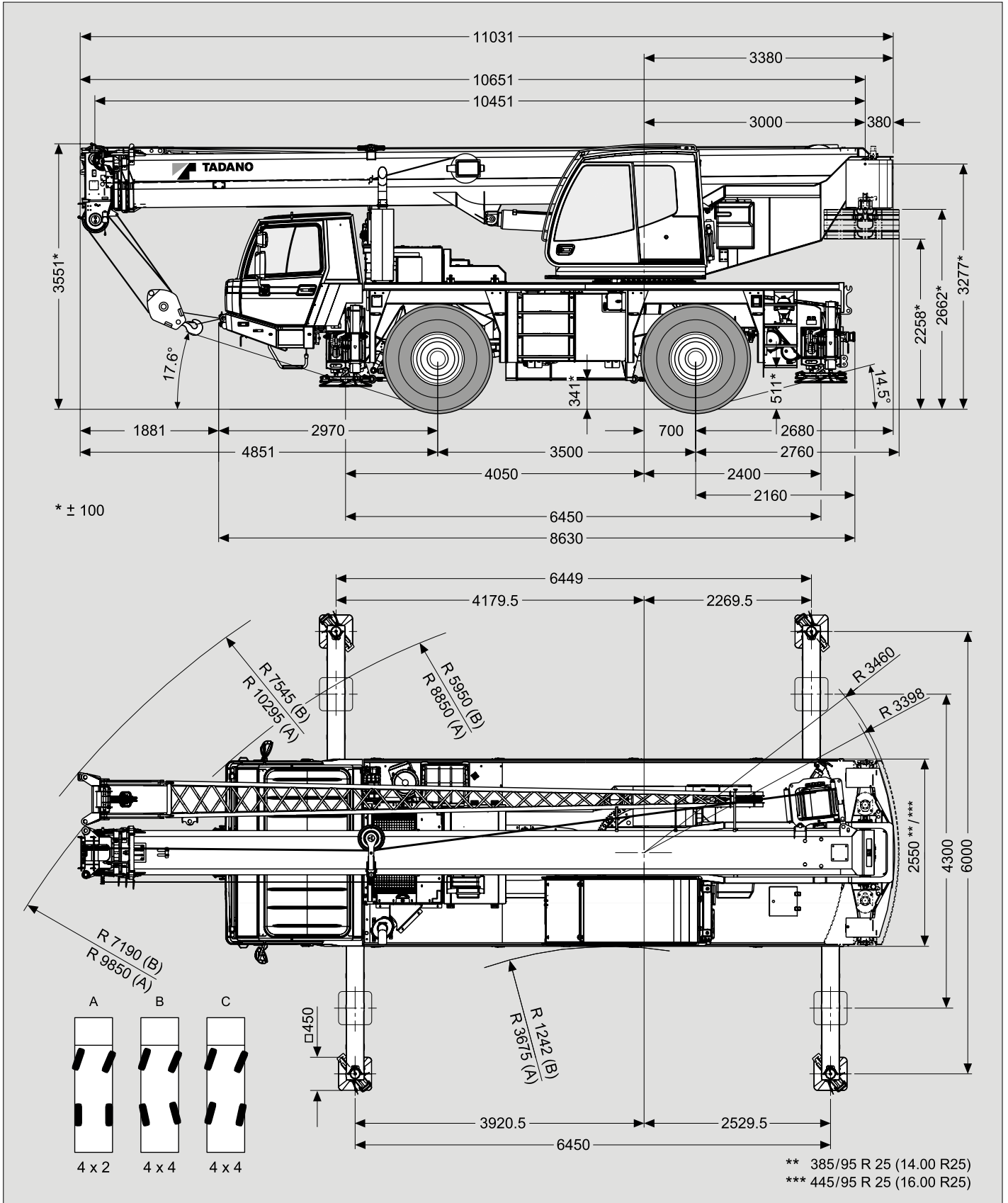

Gewichte / Geschwindigkeiten
Weights / Working speeds
Poids / Vitesses
Pesos / Velocidades de trabajo

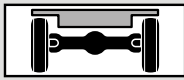
	Achse / Axle Essieu / Eje	1	2	Gesamtgewicht / Total weight Poids total / Peso total
	(t)	12	12	24*

* Incl. 1,4 t Gegengewicht, 9 m Auslegerverlängerung, Unterflasche, Antrieb 4 x 4, Bereifung 445/95 R 25 (16.00 R 25).







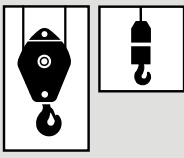

* Incl. 1.4 t counterweight, 9 m boom extension, hook block, drive 4 x 4, tyres 445/95 R 25 (16.00 R 25).



* Incl. de 1,4 t contrepoids, 9 m flèche, moufle, entraînement 4 x 4, pneus 445/95 R 25 (16.00 R 25).

* Incl. contrapeso de 1,4 t, 9 m plumin, gancho, tracción 4 x 4, neumáticos 445/95 R 25 (16.00 R 25).

	Traglast / Lifting capacity / Force de levage / Capacidad de elevación	Rollen / Sheaves Pulies / Poleas	Stränge / Parts of line Brins / Ramales de cable	Gewicht / Weight Poid / Peso
	29.1 t (Typ / Type / Typo 32)	5	9	280 kg
	19.6 t (Typ / Type / Typo 20)	3	6	200 kg
	9.9 t (Typ / Type / Typo 10)	1	3	150 kg
	3.4 t (Typ / Type / Typo 4)	–	1	75 kg

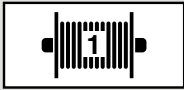

		1	2	3	4	5	6	R	
 385/95 R 25 (14.00 R 25)		5	7	11	17	27	41	5	74%
km/h		10	15	24	36	56	85	10	40%
 445/95 R 25 (16.00 R 25)		5	8	12	19	29	44	5	65%
km/h		10	16	26	39	61	85	11	36%

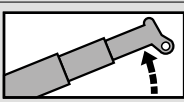
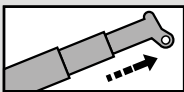
V+ 	Stufenlos Infinitely variable Progressivement variable Infinitamente variable	Seil Rope Câble Cable	Max. Seilzug Max. single line pull Effort maxi au brin simple Trio máximo por ramal
	0 - 130 m/min für einfachen Strang single line au brin simple ramal simple	14 mm / 150 m	33 kN
	0 - 2 min ⁻¹		
	- 0.5° – + 79° ca. 36 s approx. 36 s env. 36 s aproximadamente 36 s		
	10.45 m – 35.20 m ca. 80 s approx. 80 s env. 80 s aproximadamente 80 s		

Hubhöhen
Lifting heights
Hauteurs de levage
Alturas de elevación

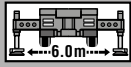
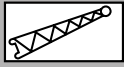
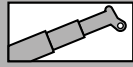

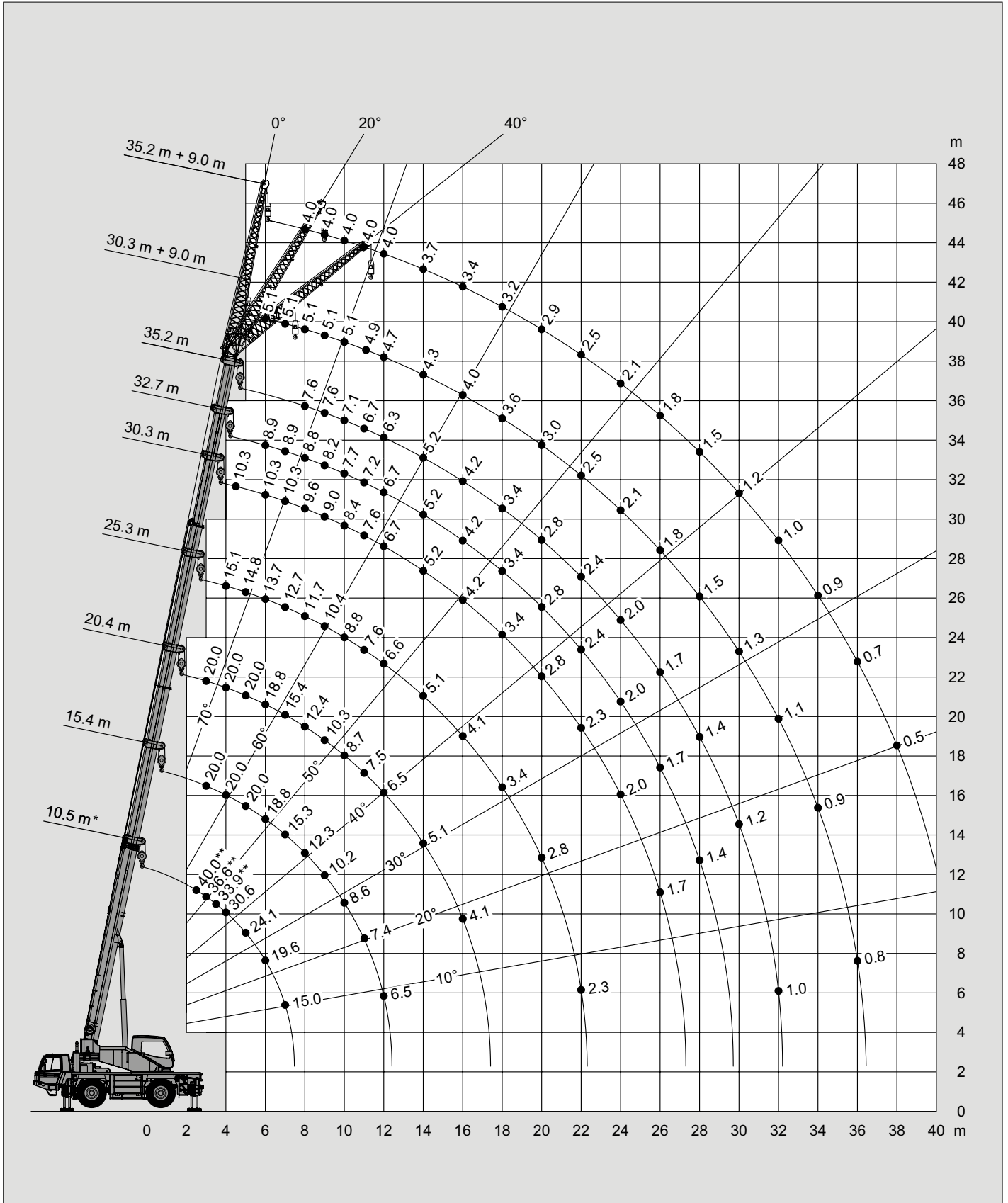

6.5t

DIN/ISO/EN



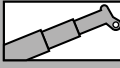
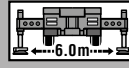

Tragfähigkeiten
Lifting capacities
Capacités de levage
Capacidades de elevación

   6.5t		DIN/ISO/EN						
 m	10.5 m*	10.5 m	15.4 m	20.4 m	25.3 m	30.3 m	32.7 m	35.2 m
2.5	40.0**							
3.0	36.6**	32.1**	20.0	20.0	15.1			
3.5	33.9**	29.0	20.0	20.0	15.1			
4.0	30.6	26.4	20.0	20.0	15.1			
4.5	27.0	24.2	20.0	20.0	15.1	10.3		
5.0	24.1	22.2	20.0	20.0	14.8	10.3		
6.0	19.6	18.6	18.8	18.8	13.7	10.3	8.9	7.6
7.0	15.0	15.0	15.3	15.4	12.7	10.3	8.9	7.6
8.0			12.3	12.4	11.7	9.6	8.8	7.6
9.0			10.2	10.3	10.4	9.0	8.2	7.6
10.0			8.6	8.7	8.8	8.4	7.7	7.1
11.0			7.4	7.5	7.6	7.6	7.2	6.7
12.0			6.5	6.5	6.6	6.7	6.7	6.3
14.0				5.1	5.1	5.2	5.2	5.2
16.0				4.1	4.1	4.2	4.2	4.2
18.0					3.4	3.4	3.4	3.4
20.0					2.8	2.8	2.8	2.8
22.0					2.3	2.3	2.4	2.4
24.0						2.0	2.0	2.0
26.0						1.7	1.7	1.7
28.0							1.4	1.4
30.0								1.2
32.0								1.0

* Nach hinten / * Over rear / * A l'arrière / * Sobre la parte trasera

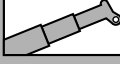
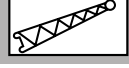
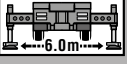
** Mit Zusatzhubausrüstungen / ** With additional lifting equipments / ** Avec équipements supplémentaires / ** Con equipos adicionales

    6.5t		DIN/ISO/EN								
 m	10.5 m + 9.0 m			30.3 m + 9.0 m			35.2 m + 9.0 m			
	0°	20°	40°	0°	20°	40°	0°	20°	40°	
3.0	6.5									
3.5	6.5									
4.0	6.5	6.5								
4.5	6.5	6.5								
5.0	6.5	6.4								
6.0	6.5	6.0		5.1						
7.0	6.5	5.6	4.7	5.1						
8.0	6.4	5.4	4.5	5.1			4.0			
9.0	6.0	5.1	4.4	5.1	4.6		4.0			
10.0	5.6	4.9	4.2	5.1	4.4		4.0			
11.0	5.3	4.6	4.1	4.9	4.2		4.0	3.7		
12.0	5.1	4.4	4.0	4.7	4.1	3.8	4.0	3.5		
14.0	4.6	4.1	3.9	4.3	3.8	3.5	3.7	3.3	3.1	
16.0	4.2	4.0		4.0	3.6	3.3	3.4	3.1	2.9	
18.0				3.6	3.4	3.2	3.2	2.9	2.8	
20.0				3.0	3.2	3.0	2.9	2.8	2.6	
22.0				2.5	2.7	2.8	2.5	2.6	2.5	
24.0				2.1	2.3	2.4	2.1	2.3	2.4	
26.0				1.8	1.9	2.0	1.8	1.9	2.0	
28.0				1.5	1.6	1.7	1.5	1.6	1.7	
30.0				1.3	1.4	1.4	1.2	1.4	1.4	
32.0				1.1	1.1		1.0	1.1	1.2	
34.0				0.9	0.9		0.9	0.9	1.0	
36.0				0.8			0.7	0.8		
38.0							0.5	0.6		



Hubhöhen
Lifting heights
Hauteurs de levage
Alturas de elevación

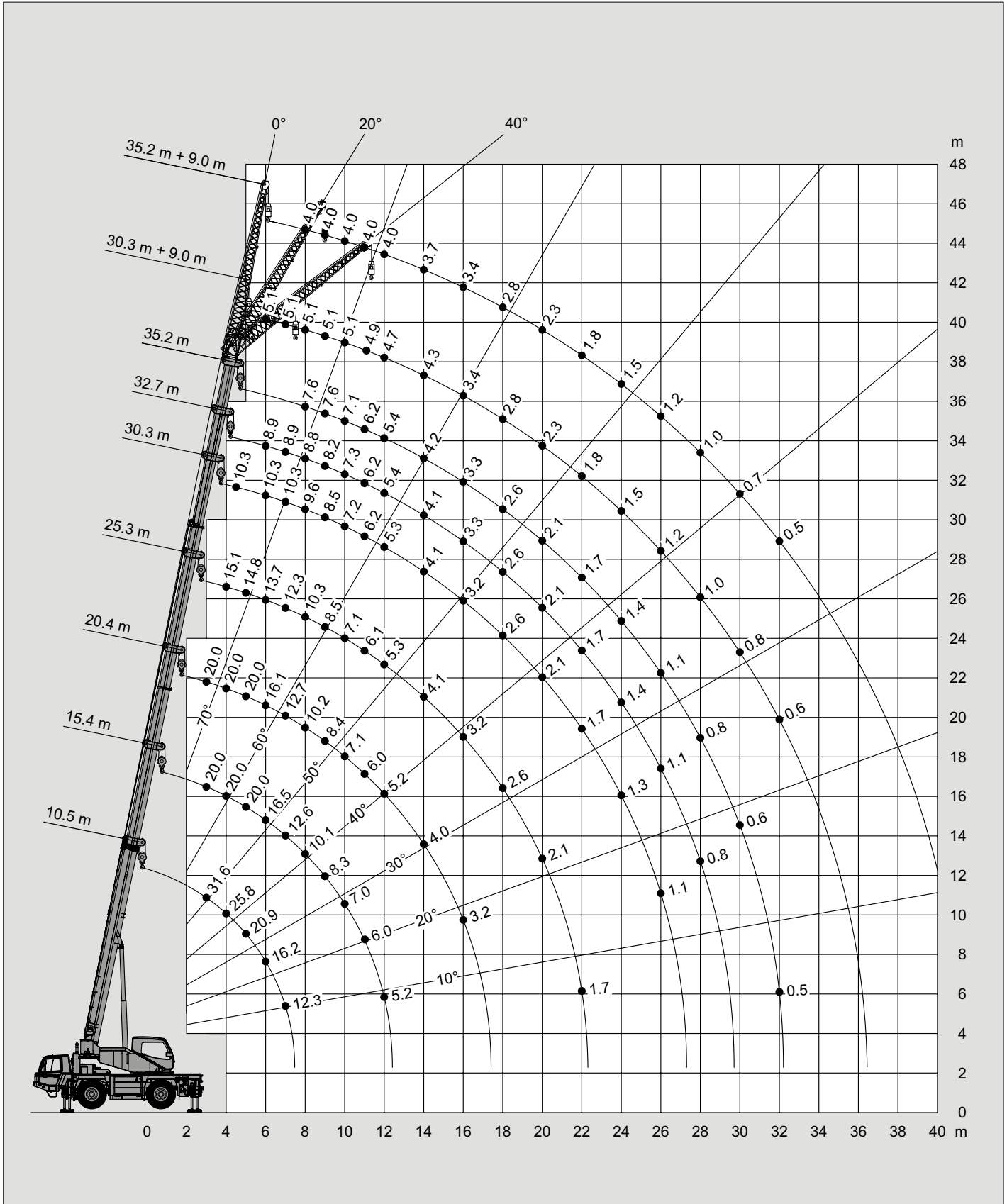

3.5t

DIN/ISO/EN

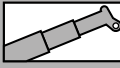
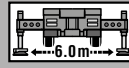

Tragfähigkeiten
Lifting capacities
Capacités de levage
Capacidades de elevación

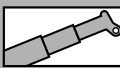
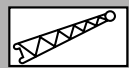
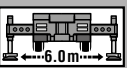
   3.5t		DIN/ISO/EN					
 m	10.5 m	15.4 m	20.4 m	25.3 m	30.3 m	32.7 m	35.2 m
3.0	31.6	20.0	20.0	15.1			
3.5	28.5	20.0	20.0	15.1			
4.0	25.8	20.0	20.0	15.1			
4.5	23.2	20.0	20.0	15.1	10.3		
5.0	20.9	20.0	20.0	14.8	10.3		
6.0	16.2	16.5	16.1	13.7	10.3	8.9	7.6
7.0	12.3	12.6	12.7	12.3	10.3	8.9	7.6
8.0		10.1	10.2	10.3	9.6	8.8	7.6
9.0		8.3	8.4	8.5	8.5	8.2	7.6
10.0		7.0	7.1	7.1	7.2	7.3	7.1
11.0		6.0	6.0	6.1	6.2	6.2	6.2
12.0		5.2	5.2	5.3	5.3	5.4	5.4
14.0			4.0	4.1	4.1	4.1	4.2
16.0			3.2	3.2	3.2	3.3	3.3
18.0				2.6	2.6	2.6	2.6
20.0				2.1	2.1	2.1	2.1
22.0				1.7	1.7	1.7	1.7
24.0					1.3	1.4	1.4
26.0					1.1	1.1	1.1
28.0						0.8	0.8
30.0							0.6
32.0							0.5

    3.5t		DIN/ISO/EN							
 m	10.5 m + 9.0 m			30.3 m + 9.0 m			35.2 m + 9.0 m		
	0°	20°	40°	0°	20°	40°	0°	20°	40°
3.0	6.5								
3.5	6.5								
4.0	6.5	6.5							
4.5	6.5	6.5							
5.0	6.5	6.4							
6.0	6.5	6.0		5.1					
7.0	6.5	5.6	4.7	5.1					
8.0	6.4	5.4	4.5	5.1			4.0		
9.0	6.0	5.1	4.4	5.1	4.6		4.0		
10.0	5.6	4.9	4.2	5.1	4.4		4.0		
11.0	5.3	4.6	4.1	4.9	4.2		4.0	3.7	
12.0	5.1	4.4	4.0	4.7	4.1	3.8	4.0	3.5	
14.0	4.6	4.1	3.9	4.3	3.8	3.5	3.7	3.3	3.1
16.0	4.0	4.0		3.4	3.6	3.3	3.4	3.1	2.9
18.0				2.8	3.0	3.2	2.8	2.9	2.8
20.0				2.3	2.5	2.6	2.3	2.5	2.6
22.0				1.8	2.0	2.2	1.8	2.0	2.2
24.0				1.5	1.7	1.8	1.5	1.7	1.8
26.0				1.2	1.4	1.4	1.2	1.4	1.5
28.0				1.0	1.1	1.2	1.0	1.1	1.2
30.0				0.8	0.9	0.9	0.7	0.9	0.9
32.0				0.6	0.7		0.5	0.6	0.7
34.0					0.5				0.5

Hubhöhen
Lifting heights
Hauteurs de levage
Alturas de elevación

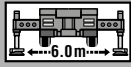
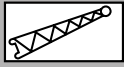
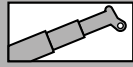



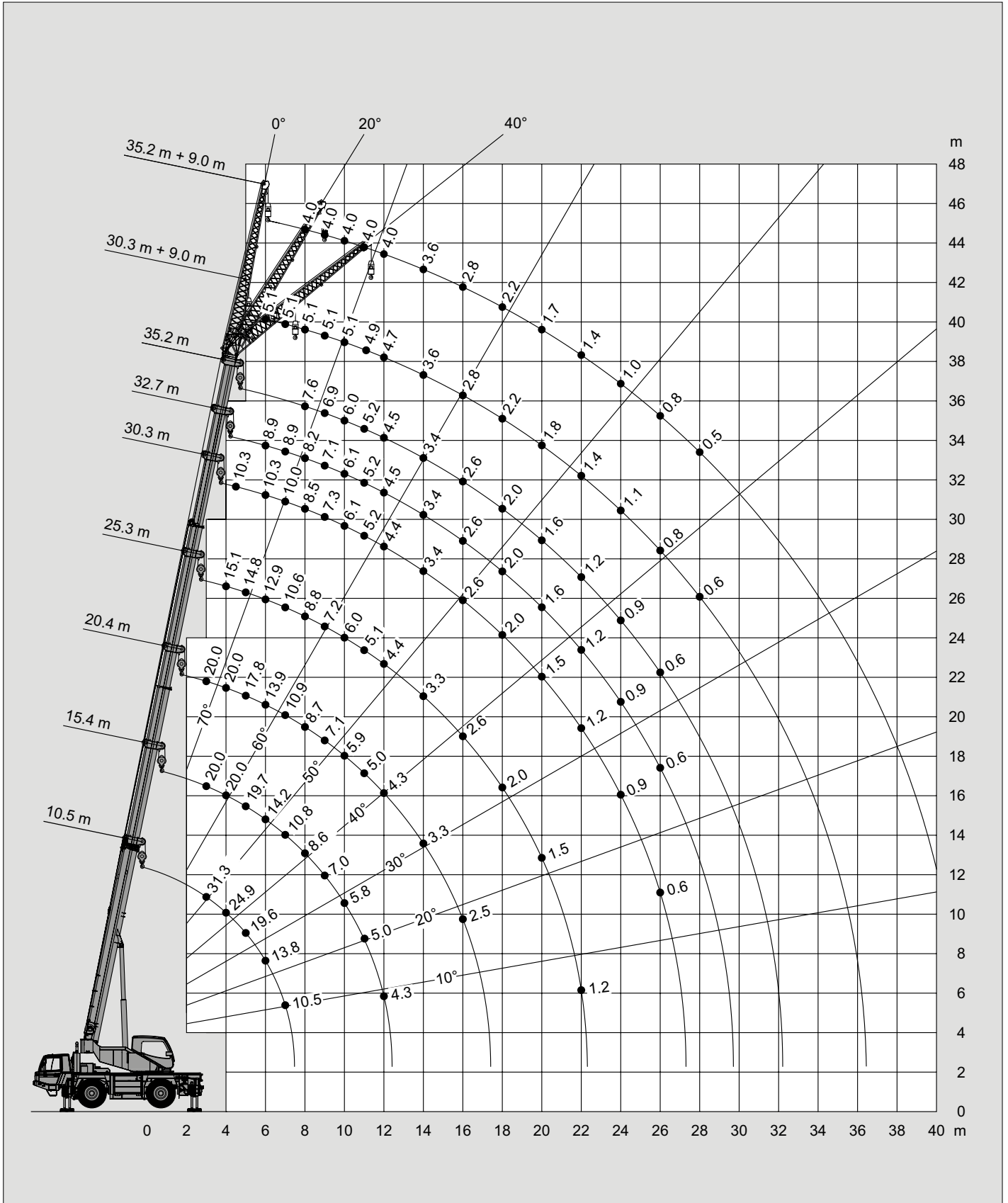

1.4t

DIN/ISO/EN

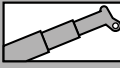
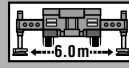

Tragfähigkeiten
Lifting capacities
Capacités de levage
Capacidades de elevación

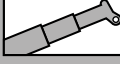
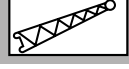
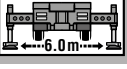
   1.4t		DIN/ISO/EN					
 m	10.5 m	15.4 m	20.4 m	25.3 m	30.3 m	32.7 m	35.2 m
3.0	31.3	20.0	20.0	15.1			
3.5	28.0	20.0	20.0	15.1			
4.0	24.9	20.0	20.0	15.1			
4.5	22.2	20.0	20.0	15.1	10.3		
5.0	19.6	19.7	17.8	14.8	10.3		
6.0	13.8	14.2	13.9	12.9	10.3	8.9	7.6
7.0	10.5	10.8	10.9	10.6	10.0	8.9	7.6
8.0		8.6	8.7	8.8	8.5	8.2	7.6
9.0		7.0	7.1	7.2	7.3	7.1	6.9
10.0		5.8	5.9	6.0	6.1	6.1	6.0
11.0		5.0	5.0	5.1	5.2	5.2	5.2
12.0		4.3	4.3	4.4	4.4	4.5	4.5
14.0			3.3	3.3	3.4	3.4	3.4
16.0			2.5	2.6	2.6	2.6	2.6
18.0				2.0	2.0	2.0	2.0
20.0				1.5	1.5	1.6	1.6
22.0				1.2	1.2	1.2	1.2
24.0					0.9	0.9	0.9
26.0					0.6	0.6	0.6

    1.4t		DIN/ISO/EN							
 m	10.5 m + 9.0 m			30.3 m + 9.0 m			35.2 m + 9.0 m		
	0°	20°	40°	0°	20°	40°	0°	20°	40°
3.0	6.5								
3.5	6.5								
4.0	6.5	6.5							
4.5	6.5	6.5							
5.0	6.5	6.4							
6.0	6.5	6.0		5.1					
7.0	6.5	5.6	4.7	5.1					
8.0	6.4	5.4	4.5	5.1			4.0		
9.0	6.0	5.1	4.4	5.1	4.6		4.0		
10.0	5.6	4.9	4.2	5.1	4.4		4.0		
11.0	5.3	4.6	4.1	4.9	4.2		4.0	3.7	
12.0	5.1	4.4	4.0	4.7	4.1	3.8	4.0	3.5	
14.0	4.1	4.1	3.9	3.6	3.8	3.5	3.6	3.3	3.1
16.0	3.3	3.4		2.8	3.1	3.3	2.8	3.1	2.9
18.0				2.2	2.5	2.7	2.2	2.5	2.7
20.0				1.8	2.0	2.1	1.7	2.0	2.2
22.0				1.4	1.6	1.7	1.4	1.6	1.7
24.0				1.1	1.2	1.3	1.0	1.2	1.4
26.0				0.8	0.9	1.0	0.8	0.9	1.0
28.0				0.6	0.7	0.8	0.5	0.7	0.8
30.0					0.5	0.5		0.5	0.6

Hubhöhen
Lifting heights
Hauteurs de levage
Alturas de elevación

Tragfähigkeiten
Lifting capacities
Capacités de levage
Capacidades de elevación

6.5t **DIN/ISO/EN**

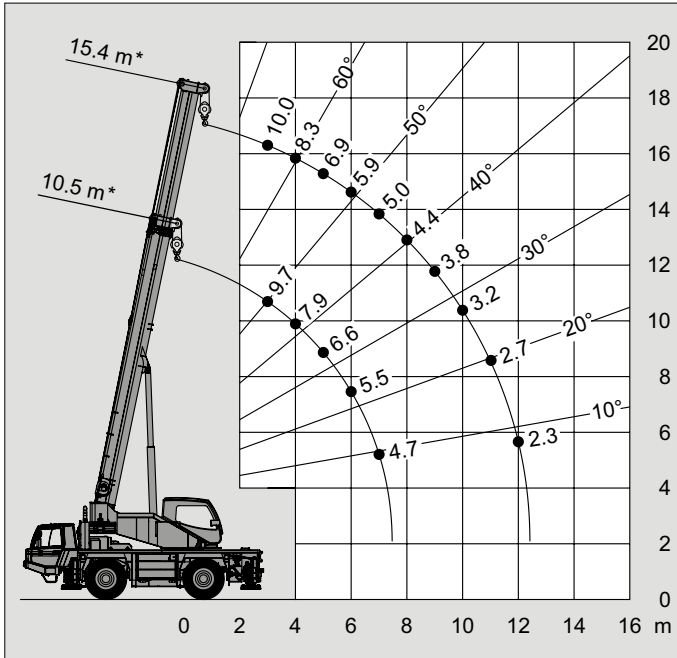

6.5t **DIN/ISO/EN**

Height (m)	10.5 m*	15.4 m*
3.0	9.7	10.0
3.5	8.8	9.1
4.0	7.9	8.3
4.5	7.2	7.5
5.0	6.6	6.9
6.0	5.5	5.9
7.0	4.7	5.0
8.0		4.4
9.0		3.8
10.0		3.2
11.0		2.7
12.0		2.3

* Oberwagenverriegelung eingelegt * Superstructure verrouillé
* Superstructure locked * Bloqueo de superestructura

3.5t **DIN/ISO/EN**

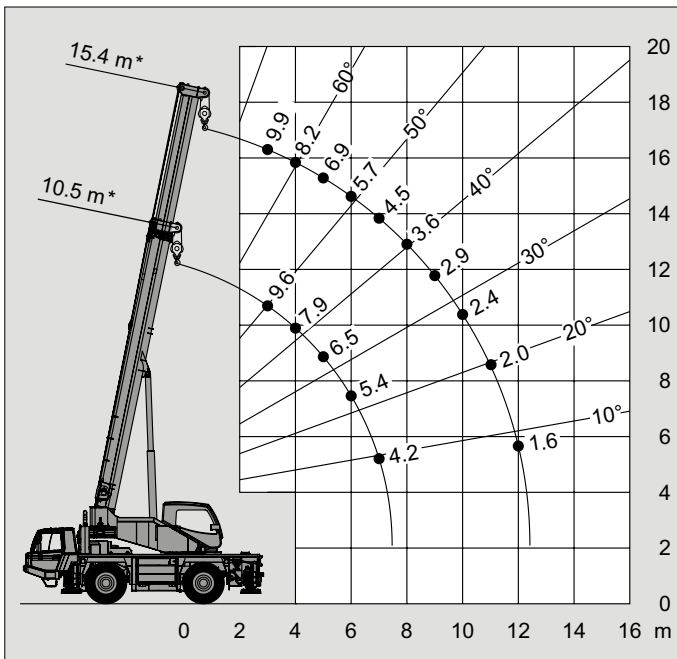

3.5t **DIN/ISO/EN**

Height (m)	10.5 m*	15.4 m*
3.0	9.6	9.9
3.5	8.7	9.0
4.0	7.9	8.2
4.5	7.1	7.4
5.0	6.5	6.9
6.0	5.4	5.7
7.0	4.2	4.5
8.0		3.6
9.0		2.9
10.0		2.4
11.0		2.0
12.0		1.6

* Oberwagenverriegelung eingelegt * Superstructure verrouillé
* Superstructure locked * Bloqueo de superestructura

Hubhöhen
Lifting heights
Hauteurs de levage
Alturas de elevación

Tragfähigkeiten
Lifting capacities
Capacités de levage
Capacidades de elevación

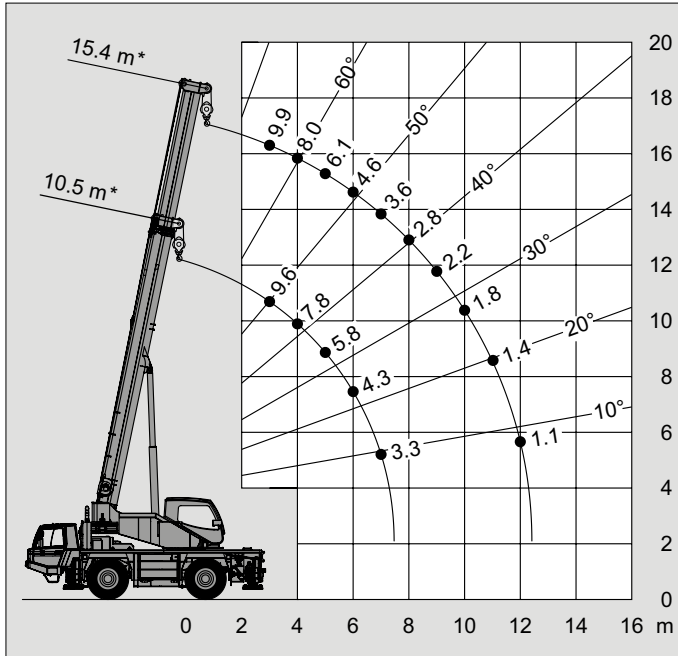

Height (m)	10.5 m *	10.5 m (360°)	15.4 m *	15.4 m (360°)
3.0	9.6	6.1	9.9	6.4
3.5	8.6	5.1	8.9	5.4
4.0	7.8	4.4	8.0	4.7
4.5	6.8	3.8	7.0	4.1
5.0	5.8	3.2	6.1	3.5
6.0	4.3	2.4	4.6	2.7
7.0	3.3	1.8	3.6	2.1
8.0			2.8	1.6
9.0			2.2	1.2
10.0			1.8	0.9
11.0			1.4	0.7
12.0			1.1	

* Oberwagenverriegelung eingelegt
* Superstructure locked

* Superstructure verrouillé
* Bloqueo de superestructura

Anmerkungen zu den Traglasttabellen
Remarks relating to the capacity charts
Remarques relatives aux tableaux des charges
Notas relativas a los graficos de carga

DIN/ISO/EN**Anmerkungen zu den Traglasttabellen**

Die Tragfähigkeiten im Festigkeitsbereich basieren auf DIN 15018 Teil 3 / F.E.M. / EN 13000.

Die Tragfähigkeiten im Standsicherheitsbereich entsprechen DIN 15019 Teil 2 / ISO 4305 / EN 13000.

Die zulässige Windgeschwindigkeit beträgt maximal 15 m/sec.

Die Tragfähigkeiten sind in metrischen Tonnen angegeben.

Das Gewicht des Lasthakens bzw. der Hakenflasche und weiterer Anschlagmittel ist von der Tragfähigkeit abzuziehen.

*Die Tragfähigkeiten für den Teleskopausleger gelten nur bei demon-
tierter Auslegerverlängerung.*

*Die Ausladung ist der horizontale Abstand von Mitte Drehkranz bis
Mitte freihängender, nicht schwingender Last.*

Tragfähigkeitsänderungen vorbehalten.

*Obige Angaben dienen nur zur Information. Die Bedienungsanlei-
tungen müssen zu Rate gezogen werden, bevor die Maschine in
Betrieb genommen wird. Alle hier gemachten Angaben beziehen
sich auf die Standard-Ausführung. Jegliche Ausrüstungsverände-
rungen können die angegebenen Werte beeinflussen.*

Remarks relating to the capacity charts

*The lifting capacities in the structural area are based on DIN 15018
part 3 / F.E.M. / EN 13000.*

*The lifting capacities in the stability area are based on DIN 15019
part 2 / ISO 4305 / EN 13000.*

*The maximum permissible wind speed for crane operation is
15 m/sec.*

The lifting capacities are shown in metric tons.

*The weight of load handling devices such as hook blocks, slings,
etc., must be considered as part of the load and must be deducted
from the lifting capacities.*

*The lifting capacities for the telescopic boom apply to a crane with
no boom extensions being stowed or mounted on the crane.*

*The working radius is the horizontal distance from the centre of
rotation to the centre of the freely suspended non-oscillating load.*

The lifting capacities are subject to change without prior notice.

*The above remarks are for basic information only and the operator's
manual must be consulted before operating this crane. All data and
performances refer to the standard crane. The addition of optional
and other equipment may affect the performance of the crane.*

Remarques relatives aux tableaux des charges

*Les forces de levage sont conformes aux normes DIN 15018,
chap. 3 / F.E.M. / EN 13000.*

*Les forces de levage dans la partie de stabilité au renversement sont
conformes aux normes DIN 15019, chap. 2 / ISO 4305 / EN 13000.*

La grue peut travailler aux vitesses de vent allant jusqu'à 15 m/s.

Les forces de levage sont données en tonnes métriques.

*Le poids du crochet-moufle et de tous les accessoires d'élingage
font partie de la charge et sont à déduire des charges indiquées.*

*Les forces de levage indiquées pour la flèche télescopique s'entendent
fléchette déposée.*

*Comme portée, on entend la distance horizontale du centre de la
couronne de rotation au centre de la charge librement suspendue
et non oscillante.*

Sauf modification de forces de levage.

*Les données ci-dessus servent à titre d'information. Avant la mise
en marche de la grue il est conseillé d'étudier les instructions de
service. Toutes les données indiquées ci-dessus se réfèrent à la
machine de base. Tout changement de l'équipement de la grue peut
influencer ces valeurs.*

Notas relativas a los graficos de carga

*En cuanto a los datos referentes a resistencia, las capacidades de
carga están basados sobre las normas DIN 15018, Cap. 3/F.E.M. /
EN 13000.*

*En cuanto a los datos referentes a estabilidad anti-vuelco, las
capacidades de carga están basados sobre las normas
DIN 15019, Cap. 2 / ISO 4305 / EN 13000.*

La velocidad anemométrica max. admisible es de 15 m/seg.

*Las capacidades de carga indicadas en las tablas corresponden a
toneladas métricas.*

*Hay que deducir los pesos del gancho, eslingas y de otros dispositivos
para fijación de cargas de los valores indicados en las tablas.*

*Las capacidades de carga referentes a la pluma telescópica valen
solamente si el plumín está desmontada.*

*Como alcance se entiende la distancia horizontal desde el centro
de la corona de giro hasta el centro de la carga suspendida libremente
y no oscilante.*

Salvo modificación de capacidades de carga, sin previo aviso.

*Los datos arriba indicados sirven solamente para su información.
Hay que leer las instrucciones para el uso antes de la puesta en
servicio de la máquina. Todos los datos mencionados en las presentes
tablas rigen para los modelos standard. Cualquier modificación del
equipo montado puede dar lugar a modi-ficaciones de aquellos
valores.*

Gegengewichtvarianten
Counterweight versions
Variations des contrepoids
Variaciones de contrapeso

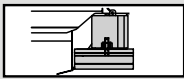
	Gegengewicht / Counterweight Contrepoids / Contrapeso	①	②	③	④	⑤	⑥	⑦
	(t)	0.7	0.7	1.0	0.7	2.0	1.2	0.2

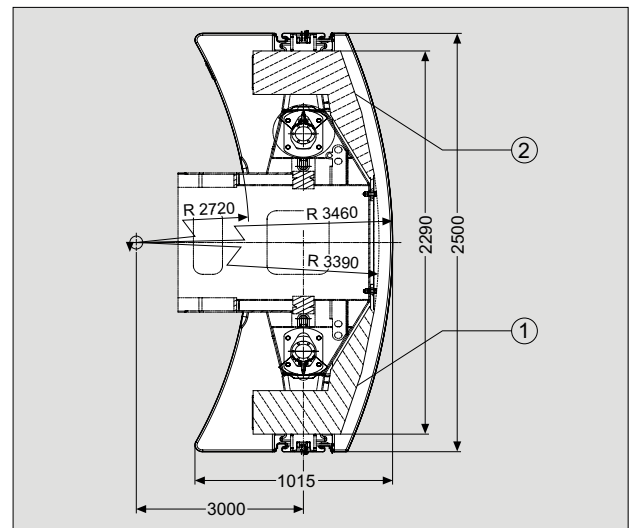
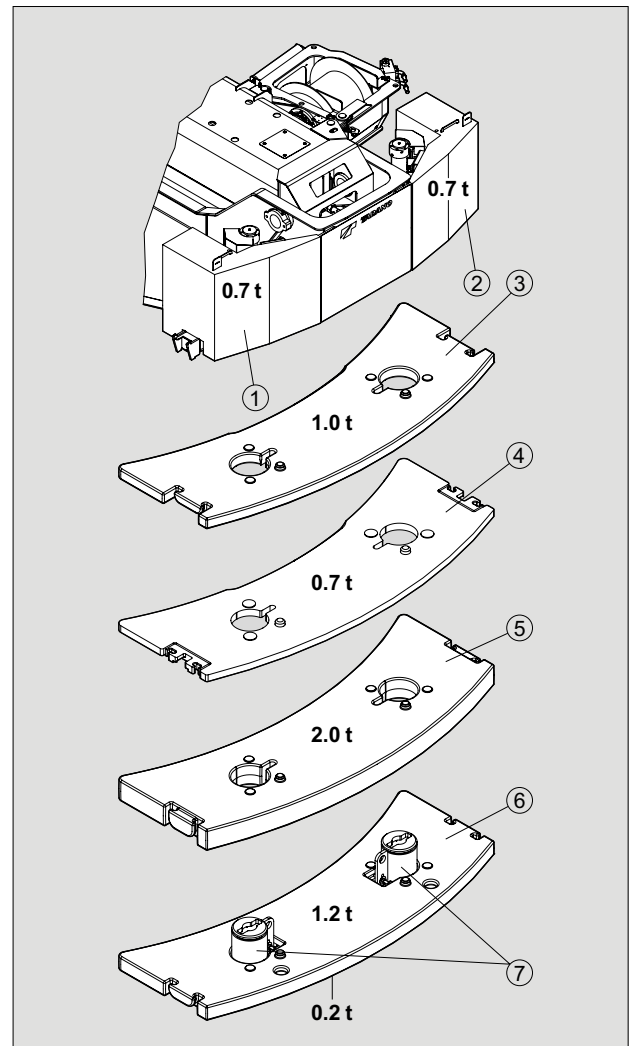
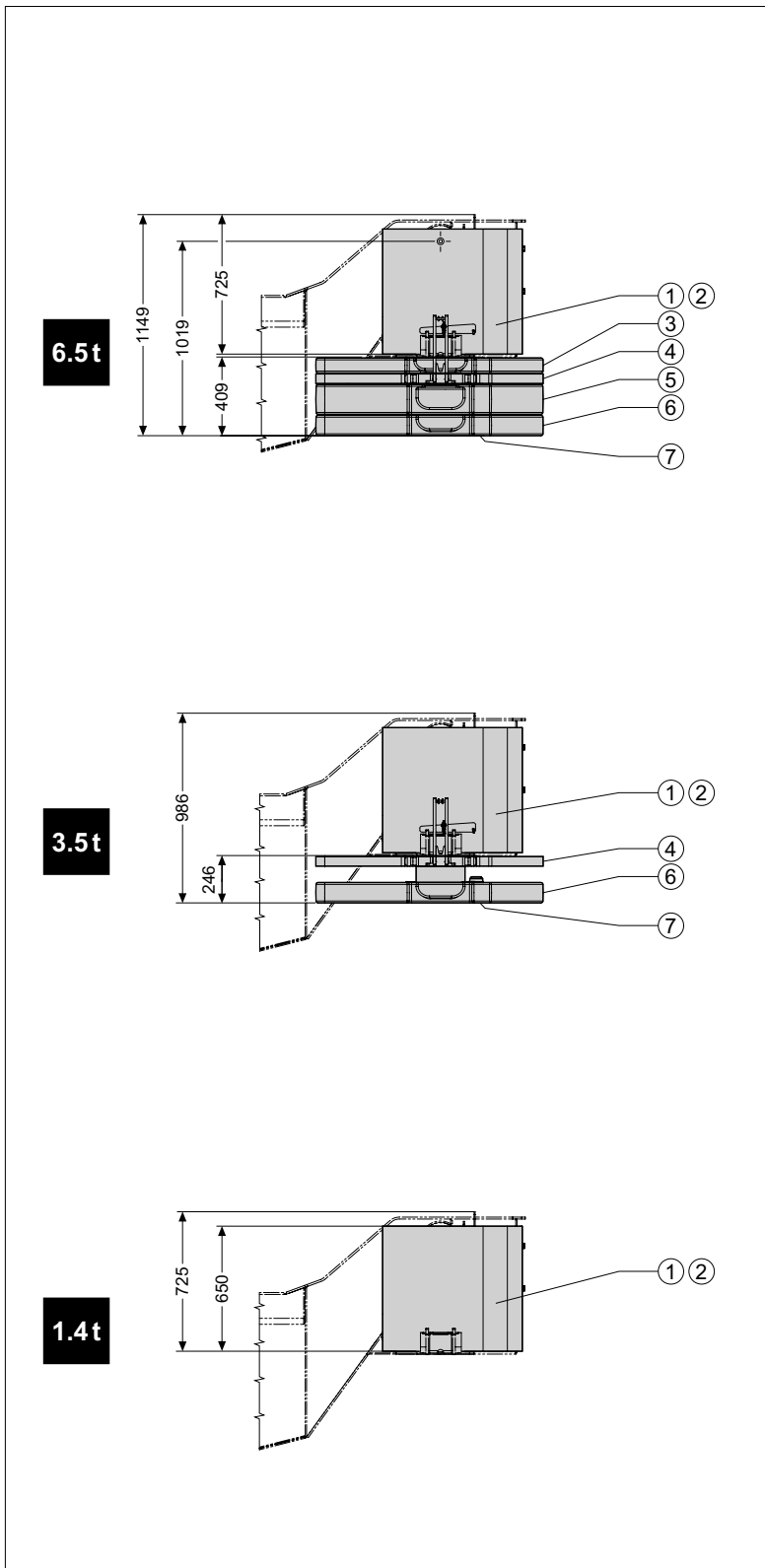

Ausrüstung

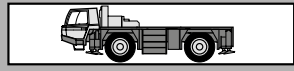

Rahmen Verwindungs- und biegesteife Schweißkonstruktion aus hochfestem Feinkornstahl.

Abstützung 4-Punkt-Abstützung, hydraulisch, Bedienungsmöglichkeiten an beiden Seiten des Fahrgestelles und in der Oberwagenkabine.

Abstützbasis 6,0 m (und 4,3 m) x 6,45 m.

Motor Mercedes-Benz 6-Zylinder-Dieselmotor OM 906 LA (Euromot III A/EPA III), wassergekühlt, Leistung 205 kW (279 PS) bei 2200 min⁻¹. Drehmoment 1100 Nm (112 kpm) bei 1200 - 1600 min⁻¹. Motorleistung nach 80 / 1269 / EWG. Kraftstoffbehälter 300 l.

Getriebe ZF-Lastschaltgetriebe 6 WG 210 mit integriertem Verteilergetriebe, Drehmomentwandler und "Lock-up"-Kupplung (ab 1. Gang). Schaltung mit 6 Vorwärts- und 1 Rückwärtsgang.

Antrieb 4 x 4

Achsen

1. Achse: gelenkt, angetrieben, Differentialsperre quer.
2. Achse: gelenkt, angetrieben, Differentialsperre quer.

Achsaufhängung Hydropneumatische Federung mit Niveauregulierung.

Bremsen Druckluft-Zweikreis-Bremsanlage mit ABS System. Feststellbremse als Federspeicherbremse an der 1. und 2. Achse wirkend. Konstantdrosselanlage mit Auspuffklappenbremse als Dauerbremse.

Räder 4-fach 385/95 R 25 (14.00 R 25).

Lenkung ZF-Servocom-Zweikreis-Hydraulenlenkung. Mechanische Lenkung der 1. Achse, hydraulisch unterstützt, mit Notlenkpumpe. Lenkung beider Achsen möglich. Hydrostatische Lenkung aller Achsen aus der Oberwagenkabine.

Unterswagenkabine Zwei-Mann-Frontfahrerhaus in Stahl-Kunststoff-Verbund-Konstruktion, Sicherheitsverglasung, luftgedeperte Sitze und motorabhängige Warmwasserheizung, Kontroll- und Bedienungselemente für den Fahrbetrieb. Tempomat-Funktion.

Elektrische Anlage 24 Volt-Gleichstrom, 2 Batterien, Die elektrische Anlage entspricht der EG-Norm.

Zusatzausrüstung (gegen Mehrpreis)
Anhängerkupplung, Wirbelstrombremse, motorunabhängige Zusatzheizung mit Motorvorwärmung, Klimaanlage, 445/95 R 25 (16.00 R 25) Bereifung, Reserverad, Sonderlackierung und Beschriftung.
Weitere Zusatzausrüstung auf Anfrage.

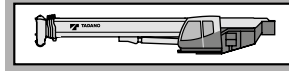

Rahmen Verwindungssteife Schweißkonstruktion mit einer außenverzahnten, einreihigen Kugeldrehverbindung, um 360° unbegrenzt drehbar.

Hydraulik System Diesel-hydraulisch mit 3-Kreis-Hydraulik, 1 Axialkolbendoppelpumpe (hydraulisch verstellbar) und 1 Zahnradpumpe, Ölkühler. Pumpen vom Fahrmotor angetrieben. Bei Kranbetrieb: 188 kW (255 PS) bei 1650 min⁻¹ (DIN 6270B).

Steuerung Zwei 4-fach Kreuzsteuerhebel mit hydraulischer Vorsteuerung.

Teleskopausleger Vierteiliger Teleskopausleger aus hochfestem Feinkornstahl, bestehend aus einem Grundausleger und 3 Teleskopteilen, einstufigem Teleskopzylinder und Seilen, hydraulisch unter Teillast teleskopierbar. 10,45 m - 35,2 m lang. Rollenkopf mit 5 Seilrollen.

Wippwerk Differentialzylinder mit angebautelem Senkbremssperrventil.

Hubwerk Axialkolben-Motor, Hubwerkstrommel mit eingebautem Planetengetriebe und federbelasteter Hydro-Lamellenbremse mit integriertem Freilauf beim Heben. Hubseil mit 'Super-Stop' Einrichtung.

Drehwerk Axialkolben-Motor, zweistufiges Planetengetriebe mit fußbetätigter Betriebsbremse und Feststellung. Drehgeschwindigkeit stufenlos von 0 - 2 min⁻¹.

Gegengewicht Standard 1,4 t.

Oberwagenkabine Großräumige Krankabine in Stahl-Kunststoff-Ausführung mit Sicherheitsverglasung und getönten Scheiben, mit verstellbarem, hydraulisch gedämpftem Fahrersitz, motorunabhängige Warmwasserheizung, Klimaanlage, Kontroll- und Bedienungselemente für Kranbetrieb, Verfahrbarkeit vom Oberwagen und Abstützbetätigung.

Elektrische Anlage 24 Volt-Gleichstrom.

Sicherheitseinrichtungen Lastmomentbegrenzung (LMB), Arbeitsbereichsanzeige, Arbeitsbereichsbegrenzung, Hubendschalter, Windenendschalter, Seilwindendrehmelder, Sicherheitsventile gegen Rohr- und Schlauchbrüche. Sperrventile an Hydraulik-Zylindern.

Zusatzausrüstung (gegen Mehrpreis)
Auslegerverlängerung 9,0 m, abwinkelbar 0°, 20° und 40°, Zusatzgegengewicht 5,1 t, Gegengewichtsvariante 3,5 t, verschiedene Unterflaschen, Zusatzölkühler, Sonderlackierung und Beschriftung.

Weitere Zusatzausrüstung auf Anfrage.

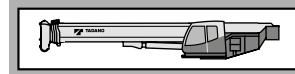
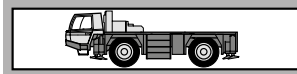

Frame Torsion resistant, welded construction made from high strength, fine-grained steel.

Outriggers 4 point, telescopic hydraulic outriggers with controls on both sides of carrier and in superstructure cab. Outrigger base 6.0 m (4.3 m mid extension) x 6.45 m.

Carrier engine Mercedes-Benz 6 cylinder model OM 906 LA (Euromot III A/ EPA III), water-cooled diesel engine. Rated at 205 kW (279 HP) at 2200 min⁻¹. Torque 1100 Nm (112 kpm) at 1200 - 1600 min⁻¹. Engine rating according to 80 / 1269 / EWG. Fuel tank 300 l.

Transmission ZF Powershift transmission 6 WG 210 with integrated transfer case, hydrodynamic torque converter (with "lock-up" from 1st gear) and with 6 forward gears and 1 reverse gear.

Drive 4 x 4

Axles

1st axle: steered, driven, with differential lock.
2nd axle: steered, driven, with differential lock.

Suspension Hydro-pneumatic with levelling adjustment.

Brake system Service brakes: dual circuit compressed air system with ABS. Parking brake: spring loaded type acting on 1st and 2nd axles. Auxiliary brakes: engine exhaust brake and constant throttle engine brake system.

Tyres (4) 385/95 R 25 (14.00 R 25).

Steering system ZF-Servocom, dual circuit hydraulic steering, mechanical steering of front axle with hydraulic assistance and emergency steering pump. Steering of both axles possible. All axles steered hydrostatically from superstructure cab.

Carrier cab Two man full width cab of composite (steel sheet metal and fibre-glass) structure, with safety glass, air-cushioned adjustable seats, engine dependent hot-water heater. Complete controls and instrumentation for road travel. Speed control.

Electrical system 24 volt DC system, 2 batteries, Electrical system conforms with EEC regulations.

Optional Equipment (at extra charge)

Towing attachment, eddy current retarder brake, engine independent additional heater with engine pre-heat, air conditioning, 445/95 R 25 (16.00 R 25) tyres, spare wheel and tyre, special painting and lettering.

Further optional equipment available upon request.

Frame Torsion-resistant, all-welded structure of high strength steel. Connected to carrier by single-row ball-bearing slewing ring with external gearing for 360° continuous rotation.

Hydraulic system Three circuit diesel hydraulic system with 1 double axial piston pump (hydraulically adjustable) and 1 gear pump, oil cooler. Pumps driven by carrier engine rated at 188 kW (255 HP) at 1650 min⁻¹ (DIN 6270B).

Controls Hydraulic, 2 joy-stick levers for simultaneous operation of crane motions.

Telescopic boom 4 sections, made of high tensile, fine-grained steel, consisting of 1 base section and 3 telescoping sections, single telescopic cylinder and ropes. All telescope sections extendable under partial load. 10.45 m to 35.2 m long. Boom head with 5 sheaves.

Derricking system 1 double acting hydraulic cylinder with integral brake and holding valve.

Main winch Axial piston motor, winch drum with integrated planetary reduction and with hydraulically controlled spring-loaded, multiple disc brake and with integrated free rotation (no sagging of load when hoisting). Hoist cable with 'Super-Stop' easy reeving system.

Slewing system Axial piston motor with two-stage planetary reduction with a foot actuated service and a parking brake. Speed infinitely variable 0 - 2 min⁻¹.

Counterweight Standard 1.4 t.

Superstructure cab Spacious panoramic cab of composite structure with safety (tinted) glass windows with hydraulically cushioned adjustable seat, engine independent hot-water heater, air conditioning. Complete controls and instrumentation for crane operation, on-site travelling and outriggers.

Electrical system 24 volt DC system.

Safety devices Load moment device (LMD), working area display, working area limitation, hoist limit switch, lower limit switch and drum turn indicator, safety valves against pipe and hose rupture. Holding valves on hydraulic cylinders.

Optional Equipment (at extra charge)

Boom extension 9.0 m, offsets 0°, 20° and 40°, additional counterweight 5.1 t, counterweight variation 3.5 t, selection of hook blocks, additional oil cooler, special painting and lettering. Further optional equipment available upon request.

Équipement

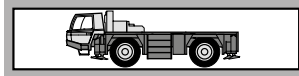

Châssis Construction mécanosoudée, en acier à grain fin très rigide, résistant aux flexions et aux torsions.

Calage Dispositif de calage horizontal et vertical en 4 points, entièrement déployable hydrauliquement. Commande des mouvements sur les deux côtés du porteur et depuis la cabine de la superstructure. Calage 6,0 m (aussi 4,3 m) x 6,45 m.

Moteur Mercedes-Benz diesel 6 cylindres, modèle OM 906 LA (Euromot III A/EPA III), refroidi par eau, de 205 kW (279 CV) à 2200 min⁻¹.
Couple: 1100 Nm (112 kpm) à 1200 à 1600 min⁻¹.
Puissance selon 80 / 1269 / EWG.
Capacité du réservoir 300 l.

Boîte de vitesse Boîte powershift ZF 6 WG 210, avec convertisseur de couple et embrayage "Lock up" (à partir de la 1^{ère} vitesse), avec 6 vitesses AV et 1 vitesse AR.

Entraînement 4 x 4

Essieux

1^{er} essieu: directeur, entraîné, blocage de différentiel transversal.

2^{ème} essieu: directeur, entraîné, blocage de différentiel transversal.

Suspension Hydro-pneumatique, avec réglage de niveau.

Freins Système à air comprimé, à double circuit, avec système ABS. Frein de stationnement: avec accumulateurs à ressort agissant sur le 1^{er} et 2^{ème} essieu. Frein continu: Frein sur échappement avec étrangleur.

Pneus 4 x 385/95 R 25 (14.00 R 25).

Direction Servocom à double circuit, marque ZF. Direction mécanique du 1^{er} essieu, à assistance hydraulique, avec pompe de direction auxiliaire. Direction des 2 essieux possible. Direction hydro-statique de tous les essieux depuis la cabine du grutier.

Cabine Cabine bi-place, construction en matière composite fibre de verre et acier. Vitrage en verre de sécurité, sièges à suspension pneumatique. Chauffage à eau chaude relié au moteur. Organes de contrôle et de commande pour la conduite. Régulateur de vitesse.

Système électrique 24 V courant continu, 2 batteries. Conforme aux normes CE.

Équipement supplémentaire (avec supplément de prix)
Attache-remorque, frein électrique, chauffage auxiliaire indépendant du moteur avec préchauffage du moteur, climatisation, pneus 445/95 R 25 (16.00 R 25), roue de secours, peinture spéciale et inscription.

Autres équipements supplémentaires sur demande.

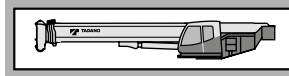

Plate forme Construction mécano-soudée résistante à la torsion. Couronne d'orientation à billes à une rangée, à denture extérieure, permettant une rotation illimitée sur 360°.

Système hydraulique Diesel-hydraulique à 3 circuits, 1 double pompe à pistons axiaux (à réglage hydraulique) et 1 pompe à engrenages, refroidisseur d'huile, pompes actionnées du moteur châssis.
Opération grue: 188 kW (255 CV) à 1650 min⁻¹ selon DIN 6270B.

Commande 2 manipulateurs à commande en croix (4 sens), assistés hydrauliquement.

Flèche télescopique 1 flèche de base et 3 éléments télescopiques en acier fin avec 1 vérin hydraulique à 1 étage et câbles, hydrauliquement télescopable avec charge partielle. Logueur 10,45 m à 35,2 m. Tête de flèche avec 5 poulies.

Mécanisme de relevage 1 vérin différentiel muni de clapet de freinage de descente.

Mécanisme de levage Moteur hydraulique, tambour de levage avec boîte planétaire incorporée, frein d'arrêt à disques multiples à ressort, libéré lors du levage. Câble de levage avec dispositif 'Super-Stop'.

Orientation Moteur hydraulique avec entraînement planétaire à 2 gammes. Frein de service actionné par l'intermédiaire d'une pédale et frein de stationnement. Vitesse de rotation 0 - 2 min⁻¹.

Contrepoids Standard 1,4 t.

Cabine du grutier Cabine de grue spacieuse, construction en matière combinée acier / synthétique, avec vitrage de sécurité en verre teinté, siège réglable et amorti hydrauliquement, inclinable avec instruments de commande, chauffage à air chaude, indépendant du moteur, climatisation, éléments de commande et de contrôle pour travaux sur chantier, conduite et calage de la grue depuis la cabine du grutier.

Système électrique 24 V courant continu.

Dispositifs de sécurité Limiteur de charge (CEC), indicateur de portée, limitation de portée, interrupteur de fin de course de levage et de treuil, indicateur du nombre de tours, soupapes de sécurité contre ruptures des conduites et flexibles, clapets sur vérins hydrauliques.

Équipement supplémentaire (avec supplément de prix)
Fléchette 9,0 m, inclinable à 0°, 20° et 40°, contrepoids additionnel de 5,1 t, combinaison différentes de contrepoids 3,5 t, sélection de moufles, refroidisseur d'huile supplémentaire, peinture spéciale et inscription.

Autres équipements supplémentaires sur demande.

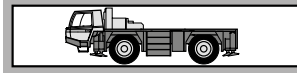

Chasis portante Construcción de acero de alta resistencia soldado, resistente a la torsión y a la flexión.

Estabilizadores Estabilizadores hidráulicos de 4 puntos. Posibilidad de manejo desde ambos lados del chasis portante y desde la cabina de la grúa. Extensión de los estabilizadores: 6,0 m (y 4,3 m) x 6,45 m.

Motor Mercedes-Benz modelo OM 906 LA (Euromot III A/EPA III), 6 cilindros, diesel, refrigerado por agua. Nominal 205 kW (279 HP) a 2200 min⁻¹. Par 1100 Nm (112 kpm) a 1200 hasta 1600 min⁻¹. Potencia del motor según 80 / 1269 / EWG. Depósito de combustible de 300 l.

Transmisión Transmisión ZF tipo powershift 6 WG 210, con convertidor de par. Convertidor con embrague "lock-up" (a partir de la 1ª marcha). 6 marchas adelante y 1 marcha atrás.

Tracción 4 x 4

Ejes

1º eje: de dirección, accionado, con bloqueo diferencial transversal.
2º eje: de dirección, accionado, con bloqueo diferencial transversal.

Suspensión Suspensión hidroneumática con regulación de nivel.

Sistemas de frenos Accionamiento neumático de doble circuito con sistema anti bloqueo ABS. Freno de estacionamiento del tipo muelles cargados, liberados por aire, sobre los ejes 1º y 2º. Freno continuo: Freno de motor diesel en el escape.

Neumáticos 4 x 385/95 R 25 (14.00 R 25).

Dirección Hidráulica ZF Servocom de doble circuito. Giro mecánico sobre el 1º eje, asistido hidráulicamente. Bomba hidráulica de emergencia accionada por la transmisión. Dirección de los 2 ejes posible. Desde la cabina de la superestructura: dirección hidro-estática de ambos ejes.

Cabina Cabina para dos personas, en construcción de acero y fibra de vidrio. Cristales de seguridad, asiento con suspensión neumática, calefacción por agua caliente del motor. Elementos de control y manejo para circular por carretera. Regulador de velocidad.

Sistema eléctrico Sistema de 24 V c.c. con 2 baterías. El sistema eléctrico cumple la normativa CEE.

Equipo adicional (con suplemento de precio) Embrague de remolque, freno eléctrico, calefacción adicional con precalefacción del motor, climatización, neumáticos 445/95 R 25 (16.00 R 25), rueda de repuesto, pintura especial e rotulación. Otros equipamientos sobre pedido.

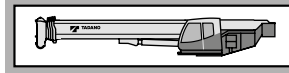

Superestructura Construida en aceros soldados, resistente a la torsión. Corona de giro con rodamiento de una fila de bolas con dientes externos para giro continuo de 360°.

Sistema hidráulico Sistema hidráulico de 3 circuitos, 1 bomba doble de pistones axiales (regulable hidráulicamente) y una bomba de ruedas dentadas, enfriador de aceite. Las bombas están accionadas desde el motor del chasis. Operación de la grúa: 188 kW (255 HP) a 1650 min⁻¹ (DIN 6270B).

Mandos 2 palancas de control de tipo joy-stick para movimientos simultáneos de la grúa (4 direcciones), asistidos hidráulicamente.

Pluma telescópica 4 secciones, un tramo base y 3 telescópicos de acero de alta resistencia soldado con 1 cilindro telescópico sencillo y cables, los tramos se pueden telescopar hidráulicamente bajo carga. Longitud de 10,45 m a 35,2 m. Cabeza de pluma con 5 poleas.

Elevación de pluma Mediante un cilindro hidráulico con válvula de retención integrada.

Cabrestante principal Motor hidráulico de pistones axiales. Tambor del cabrestante con reducción planetaria y frenos de disco múltiples accionado, con sistema libre de elevación. Cable de elevación con sistema de enhebrado fácil y 'Super-Stop'.

Sistema de giro Motor hidráulico de pistones axiales con reducción planetaria de dos etapas. Freno de servicio controlado por pedal y freno de estacionamiento. Velocidad de giro variable de 0 - 2 min⁻¹.

Contrapeso Peso total de 1,4 t.











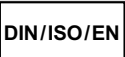
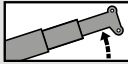
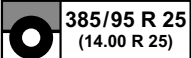
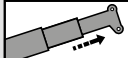

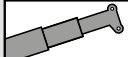
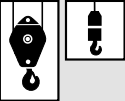



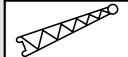

Cabina de la grúa Cabina espaciosa y confortable, en construcción de acero y fibra de vidrio, con cristales tintados de seguridad. Asiento del operador regulable amortiguado hidráulicamente, inclinable junto con los instrumentos y mandos, calefacción por agua caliente independiente del motor, climatización. Elementos de control y mando para el manejo de la grúa y para el desplazamiento en obra. Mandos para nivelación y extensión de los estabilizadores.

Sistema eléctrico Sistema de 24 V c.c.

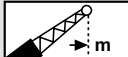
Medidas de seguridad Limitación del momento de carga (LMC), indicador del área de trabajo, limitación del área de trabajo, interruptor de final de elevación, interruptor de 3 últimas vueltas en cabrestante, indicador de bajada o subida del cable del cabrestante, válvulas de seguridad para rotura de tubos y latiguillos. Válvulas de retención en los cilindros hidráulicos.

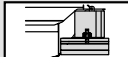
Equipo adicional (con suplemento de precio) Plumín de 9,0 m, acodable en 0°, 20° y 40°, contrapeso adicional de 5,1 t, variante de contrapeso 3,5 t, selección de ganchos, enfriador adicional, pintura especial e rotulación. Otros equipamientos sobre pedido.

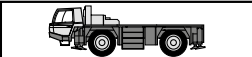
Symbolerklärung
 Symbols
 Glossaire des symboles
 Glosario de símbolos

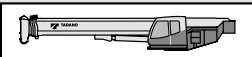
	Siehe Seite 12 As on Page 12 Voyez la page 12 Véase la pagina 12		Wippwerk Derricking system Mécanisme de relevage Elevación de pluma
	Räder / Größe Tyres / Size Pneus / Largeur Neumáticos / Tamano de ruedas		Teleskopieren Boom telescoping Télescopage de flèche Telescopaje de pluma
	Achslast Axle load Charge à l'essieu Carga por eje		Teleskopausleger Telescopic boom Flèche télescopique Pluma telescópica
	Unterflasche / Hakengeschild Hook block / Swivel hook Moufle / Elingues Gancho / Gancho de bola		Abstützung Outriggers Calage Estabilizadores
	Geschwindigkeiten Unterwagen Carrier speeds Vitesses du châssis Velocidades del chasis		Gegengewicht Counterweight Contrepoids Contrapeso
	Getriebe / Gang Transmission / Gear Boîte de vitesse / Rapport Transmisión / Marchas		Ausladung Radius Portée Radio
	Steigfähigkeit Gradeability Abtitude en pente Superacion de pendientes		Auslegerverlängerung Boom extension Fléchette Plumín
	Gelände Off road Tout-terrain Todo terreno		Nach hinten Over rear A l'arrière Sobre la parte trasera
	Straße On road En route En carretera		Ausladung Radius Portée Radio
	Geschwindigkeiten Oberwagen Superstructure speeds Vitesses du partie tournante Velocidades de la superestructura		Gegengewichtvarianten Counterweight versions Variations des contrepoids Variaciones de contrapeso
	Hubwerk Main winch Mécanisme de levage Cabrestante principal		Unterwagen Carrier Châssis Chasis
	Drehwerk Slewing system Orientation Sistema de giro		Oberwagen Superstructure Partie tournante Superestructura



You can find your **direct TADANO contact person** on:
www.tadano.com/wwnetwork/



TADANO FAUN GmbH

Faunberg 2 · 91207 Lauf a. d. Pegnitz · Germany
Phone: +49-9123-185-0 · Fax: +49-9123-3085
www.tadanofaun.de · info@tadanofaun.de

TADANO LTD. (International Division)

4-12, Kamezawa 2-chome, Sumida-ku Tokyo 130-0014, Japan
Phone: 81-3-3621-7750 · Fax: 81-3-3621-7785
www.tadano.com · info@tadano.com